

# CycleGard®





## CG400 Series

with **SMARTCYCLE**

### Low Water Cut-Offs For Steam Boilers

24 VAC Operating Voltage  
Max. Pressure 15 psi

U.S. Patent Nos. 5,739,504 & 6,390,027

-  Low maintenance. No moving parts to wear stick or hang up, as in float devices.
-  Solid state circuitry. Designed for the highest level of performance and reliability.
-  Automatically shuts off burner, after delay, in a low water condition to prevent dry firing.
-  Time delay allows water to feed above the probe to a safe operating level.
-  **INTERMITTENT LEVEL TEST** – periodically monitors settled water level for added protection of today's smaller steam boilers.

## HOW TO INSTALL

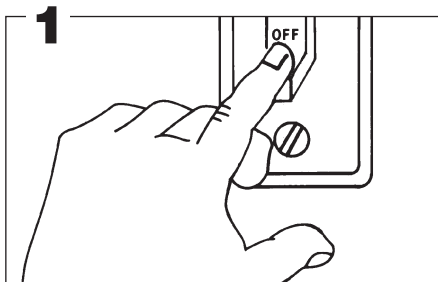

**WARNING** – To prevent electrical shock or equipment damage, power must be off during installation or servicing of the control. To prevent serious burns, the boiler should be thoroughly cooled before installing or servicing control. Only qualified personnel may install or service the control in accordance with local codes and ordinances. Read instructions completely before proceeding.

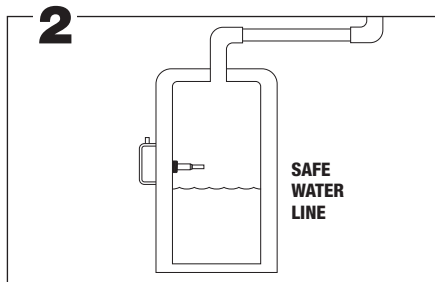

The probe may be installed in the boiler above the lowest safe water level established by the boiler manufacturer. Most manufacturers provide a suitable opening in the side of the boiler.

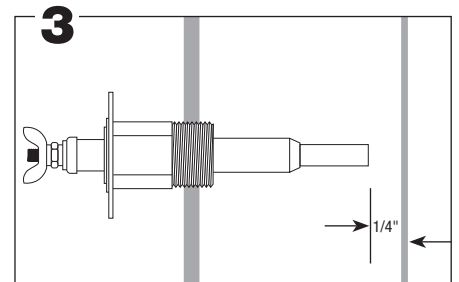

Allow 1/4" clearance from the probe to any boiler surface, tube or baffle. NOTE: Excessive use of Teflon tape to seal probe piping threads may insulate the control from boiler ground. This could result in the control not operating.

### REMOTE MOUNTED MODELS ONLY

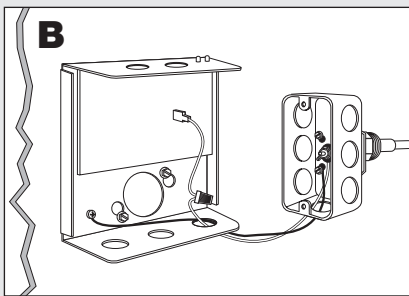
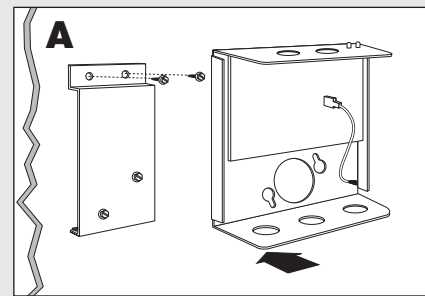

**A.** To secure mounting plate to boiler jacket,\* pre-drill two 3/32" pilot holes using the mounting plate as a template. Secure plate with sheet metal screws provided. Attach control to mounting plate by slipping keyholes in back of chassis over pre-mounted screws on plate. Tighten screws.

**B.** Using a wire nut, attach a wire (min 90°C) to the pigtail lead in the control box. Attach the other end to the probe terminal in the remote probe housing. Attach a second wire between the ground screw on the control chassis and one of the four screws in the remote probe housing. Note: Wires and wire nuts not provided.

\*Or other suitable surface

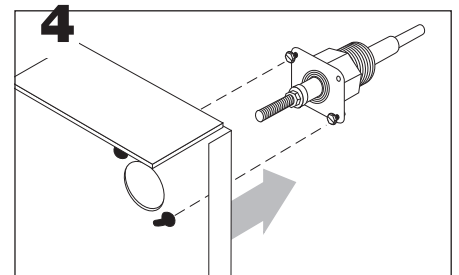

Loosen the two control cover binding head screws and remove the cover. Assemble the chassis to the probe flange and secure with the screws provided with the probe.

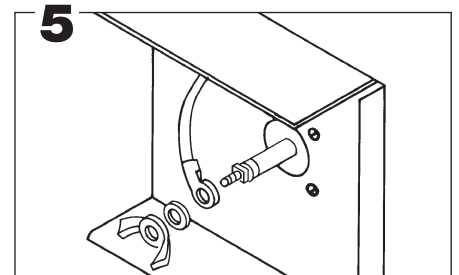

Connect the ring terminal wire lead to the probe terminal stud and secure with the lock washer and wing nut provided. With the power removed, proceed with installation and wiring according to the instructions on page 2. Upon completion of wiring replace control cover.



**WARNING** Frozen pipes/water damage. Central heating systems are prone to shut down as a result of power or fuel outages, safety related fault conditions or equipment failure. Installation of freeze protection monitoring or other precautions is recommended for unattended dwellings in climates subject to sustained below-freezing temperatures.

## HYDROLEVEL COMPANY

126 Bailey Road  
North Haven, CT 06473  
Phone: (203) 776-0473 • FAX: (203) 764-1711  
www.hydrolevel.com

# HOW TO WIRE

## MODEL CG400

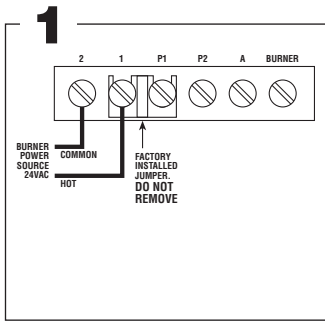

Connect input voltage (24 VAC, 60 HZ) to terminals 1 and 2.

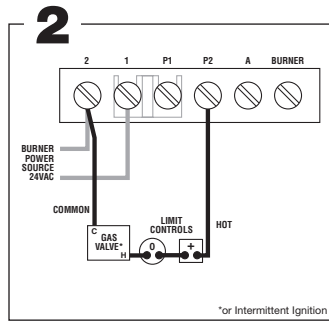

Connect terminal 2 to burner circuit common. Connect terminal P2 to burner Circuit in series with and before other limit controls. Consult boiler manufacturer instructions for proper terminal connections.

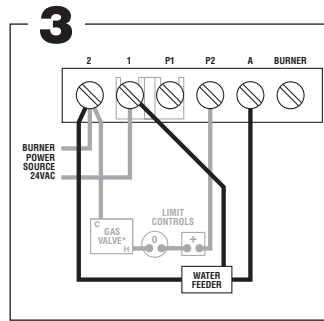

Optional water feeder connection. Connect feeder N to terminal 2. Connect Feeder H to terminal 1. Connect feeder "FEED" or "W" to terminal A. For water feeders with 2 leads, connect feeder common to terminal 2 and feeder hot to terminal A. **Note:** Use of a solenoid valve or McDonnell & Miller Model 101A water feeder may cause flooding and is not recommended for use with this low water cut-off.

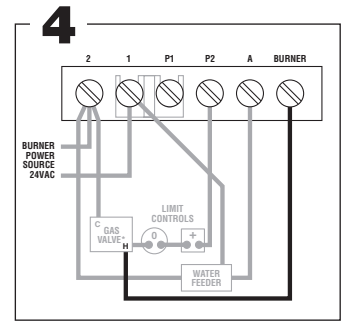

### SMARTCYCLE OPTIONAL ACTIVATION

**Standing pilot boilers:** Connect "Burner" terminal to hot leg of 24VAC connection on **gas valve**.

**Pilotless ignition boilers:** Connect "Burner" terminal to hot leg of 24VAC connection on **intermittent ignition (spark) module**.

See boiler manufacturer's installation instructions for correct connection to 24VAC hot.

## MODEL CG400 — ALTERNATE WIRING METHOD USING PLUG CONNECTOR

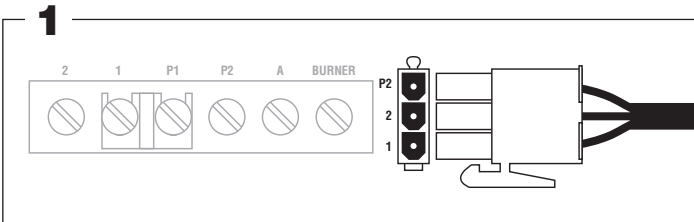

Plug wire harness connector into matching end on circuit board. **IMPORTANT:** Factory installed jumper must be in place between terminals 1 and P1.

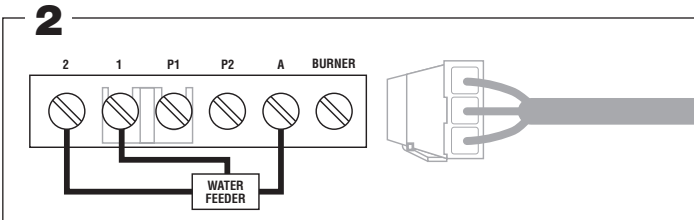

Optional water feeder connection. Connect feeder N to terminal 2. Connect Feeder H to terminal 1. Connect feeder "FEED" or "W" to terminal A. For water feeders with 2 leads, connect feeder common to terminal 2 and feeder hot to terminal A. **Note:** Use of a solenoid valve or McDonnell & Miller Model 101A water feeder may cause flooding and is not recommended for use with this low water cut-off.

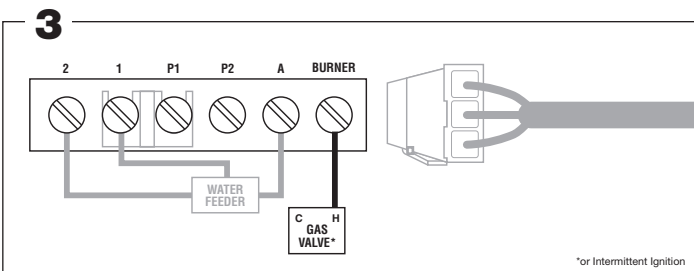

### SMARTCYCLE OPTIONAL ACTIVATION

**Standing pilot boilers:** Connect "Burner" terminal to hot leg of 24VAC connection on **gas valve**.

**Pilotless ignition boilers:** Connect "Burner" terminal to hot leg of 24VAC connection on **intermittent ignition (spark) module**.

See boiler manufacturer's installation instructions for correct connection to 24VAC hot.



## CycleGard Intermittent Level Test Feature

To provide added protection to today's smaller boilers, the CycleGard low water cut-off is equipped with an Intermittent Level Test. This important feature adds protection against false signals that can be caused by foam and volatile water conditions inside the boiler. The Intermittent Level Test removes power from the burner at preset intervals. During the test, foam dissipates and the water level stabilizes – allowing CycleGard to monitor the true water level in the boiler assuring safe and accurate operation.

The last four digits of the CycleGard model number determine the frequency and duration of the Intermittent Level Test (ILT) as follows:

Last 4 digits of Model No.	Frequency of ILT	Duration of ILT
1090	10 Minutes	90 Seconds
2090	20 Minutes	90 Seconds



When the optional SmartCycle feature is activated (see wiring instruction on previous page), the CycleGard's test time sequencing is restarted each time the burner fires. This feature enables a full burner run cycle (10 or 20 minutes, depending on model) prior to the first Intermittent Level Test.

## OPERATING INSTRUCTIONS

**NOTE:** For proper low water cut-off operation, the boiler should be cleaned at initial installation and periodically thereafter. Refer to the boiler manufacturer's instructions for cleaning procedures.

### OPERATING TEST PROCEDURE

1. After installation, bring the boiler water to a safe operating level, turn on power and set the thermostat to call for heat. The amber LED lamp should be off. **The boiler will fire immediately.**
2. *Slowly* lower the boiler water to a point below the probe. The amber LED lamp on the control will light. The lamp may begin to flicker with the bouncing water level. Stop draining the boiler when the lamp glows steadily. **NOTE:** The water should not be lowered beyond a visible point in the gauge glass.
3. The boiler will shut down within 15 seconds.

### IF BURNER DOES NOT SHUT DOWN IN LOW WATER

1. Check to see if a foaming condition in the boiler is preventing the control from accurately detecting the water level. With power to the system on, and water above the probe level, set the thermostat so there is no call for heat and allow the burner to shut down. Then, slowly lower the water in the boiler to a point below the probe. The amber LED lamp should turn on and the relay will open after a 15 second delay. Once this has occurred, reestablish a call for heat and the boiler should not fire. Now raise the water level to an operating level. The amber light should turn off and the control should reenergize the burner circuit after a 30 second delay. If the control functions normally during this test, but allows water to drop below the level of the probe when the test is conducted with the burner on (as described in the Operating Test Procedure above), the boiler is foaming. The CycleGard provides protection for foaming boilers (see CycleGard Intermittent Level Test Feature above). However, to provide optimal steaming performance, it is still recommended that you clean the boiler in accordance with the manufacturer's instructions.

- The foaming condition is caused by machining oils, elevated mineral content from make-up water, grease and other contaminants in the boiler water. Cleaning the boiler will eliminate foaming conditions in the boiler and provide for optimal steaming performance.
2. Check terminal block wiring to insure that all connections are correct.
  3. Check the probe installation to insure that there is 1/4" clearance from any surface within the boiler or pipe. (Refer to Step 3 on page 1 of this instruction sheet.

### IF THE AMBER LED LAMP IS ON

The amber LED lamp indicates that the water is below the probe. If the gauge glass shows that the water is at the correct operating level and the amber LED is lit check the following:

1. Check for plugged gauge glass.
2. Make sure probe lead wire is properly secured to the terminal.
3. Check for proper ground between probe and boiler shell. Excessive use of Teflon tape or sealing compound may isolate the probe from the boiler shell.
4. Remove probe and examine for oily residue. Clean probe with steel wool and skim boiler.

### IF THE GREEN LED LIGHT IS ON

The green LED lamp indicates that the control is conducting an Intermittent Level Test. The burner does not fire during the test period. See Intermittent Level Test Feature on this page for more details.

## MAINTENANCE

To insure optimum performance, remove and inspect the probe annually. Clean any sediment or scale from the probe using a scouring pad or steel wool. **Note: Do not use caustic chemicals that could damage the probe.** Reinstall the probe and perform the Operating Test Procedure described above.

# VXT WATER FEEDER



The VXT Water Feeder (available separately) can be installed with Hydrolevel or other low water cut-offs to automatically replenish boiler water in the event of a low water condition. The VXT offers programmable *feed amount and feed delay* settings. These can easily be set to ensure the proper feed amount and to provide adequate time for condensate to return to the

boiler before starting a feed cycle. The VXT Feeder's *Digital Feed Counter* tracks the amount of water added to the boiler exposing system leaks, which can significantly shorten the life of a cast iron boiler. Additional features including a manual feed button, underfeed and flood protection make the VXT an ideal choice for safety and convenience.

## PROBES

Test Pressure: 1000 PSI, All Models

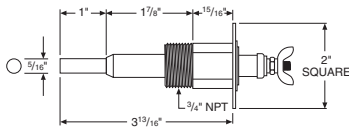

**EL1214 – STANDARD MODEL – 3/4" NPT**  
For 1/2", order Model No. EL-1220

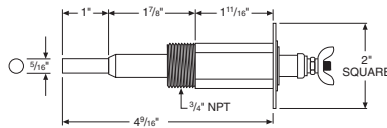

**EL1214-P – 3/4" NPT**



**EL1214-R  
REMOTE PROBE**

## THE PROBE MAKES THE DIFFERENCE

The probe used in all Hydrolevel controls offers you distinctive advantages. Unlike float devices, there are no moving parts to wear stick, or "hang-up" the in harsh boiler environment.

A stuck or "hung-up" float can cause dangerous low water conditions. And if suddenly released, a float can feed cold water into overheated tubes or plates and cause explosive results.

The Hydrolevel control has no float bowl so sediment cannot collect. The reliable solid state circuitry and low maintenance probe are designed to provide years of troublefree operation.

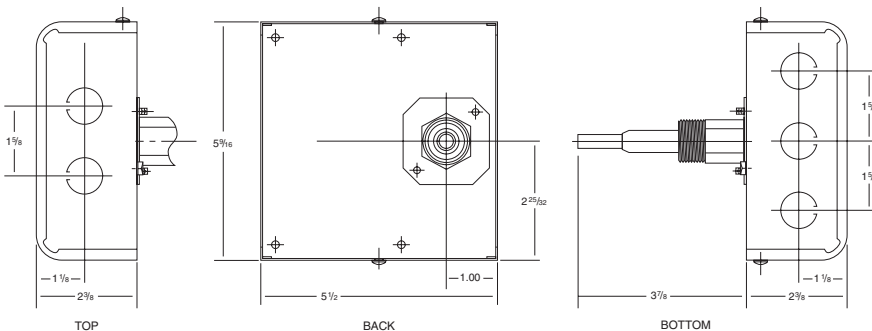

- MAXIMUM PRESSURE:** 15 PSI
- INPUT VOLTAGE:** 24 VAC, 60 HZ
- SWITCH CONTACTS:** SPDT
- SWITCH RATINGS AND ALARM CIRCUIT:** 50 VA @ 24 VAC Pilot Duty



### LIMITED MANUFACTURER'S WARRANTY

We warrant products manufactured by Hydrolevel Company to be free from defects in material and workmanship for a period of two years from the date of manufacture or one year from the date of installation, whichever occurs first. In the event of any claim under this warranty or otherwise with respect to our products which is made within such period, we will, at our option, repair or replace such products or refund the purchase price paid to us by you for such products. In no event shall Hydrolevel

Company be liable for any other loss or damage, whether direct, indirect, incidental or consequential. This warranty is your EXCLUSIVE remedy and shall be IN PLACE OF any other warranty or guarantee, express or implied, including, without limitation, any warranty of MERCHANTABILITY or fitness for a particular purpose. This warranty may not be assigned or transferred and any unauthorized transfer or assignment thereof shall be void and of no force or effect.

## HYDROLEVEL COMPANY

126 Bailey Road  
North Haven, CT 06473  
Phone: (203) 776-0473  
FAX: (203) 764-1711  
www.hydrolevel.com